

GPU PROGRAMMING FOR VIDEO GAMES

3D Coordinates & Transformations



Prof. Aaron Lanterman

(Based on slides by Prof. Hsien-Hsin Sean Lee)

School of Electrical and Computer Engineering

Georgia Institute of Technology



3D graphics rendering pipeline (1)

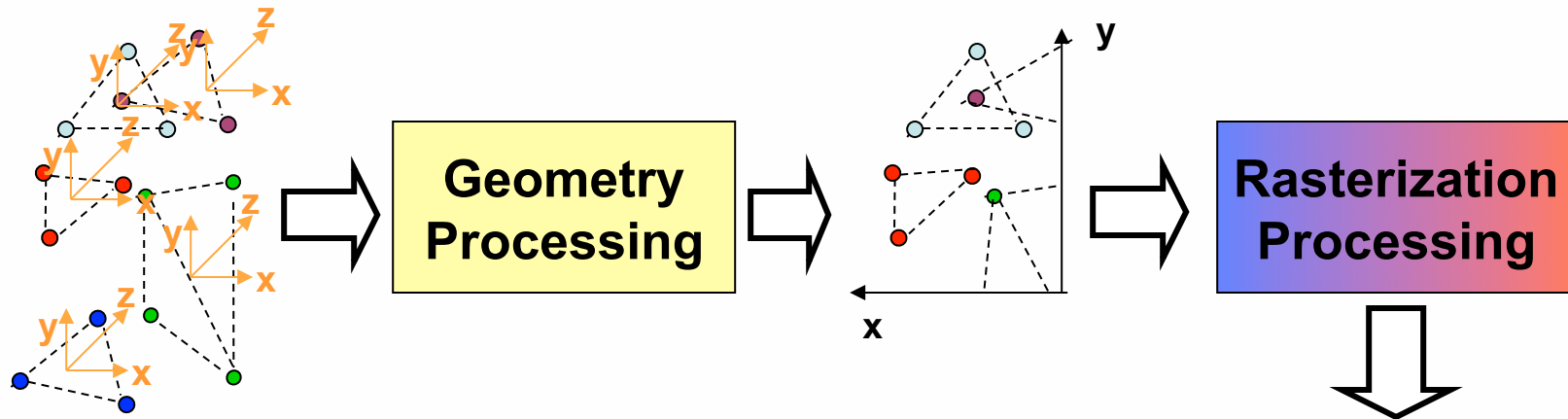

- Geometry Pipeline
 - Processing Vertices
 - Mainly floating-point operations
- Rasterization Pipeline
 - Processing Pixels
 - Mainly dealing with **Integer** operations

3D graphics rendering pipeline (2)

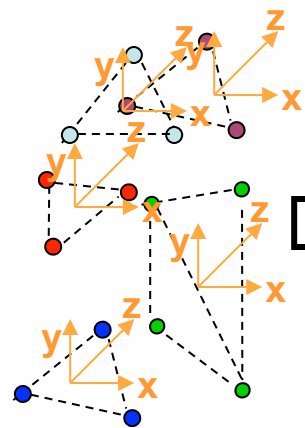

Geometry Processing

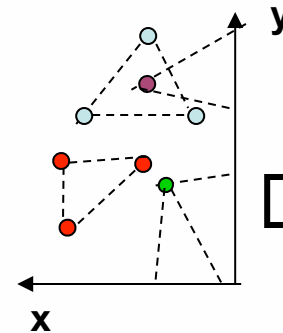

MMX ISA

Rasterization Processing

- Geometry Pipeline
 - Processing Vertices
 - Mainly floating-point operations
- Rasterization Pipeline
 - Processing Pixels
 - Mainly dealing with Integer operations
 - **MMX was originally designed to accelerate this type of functionality**

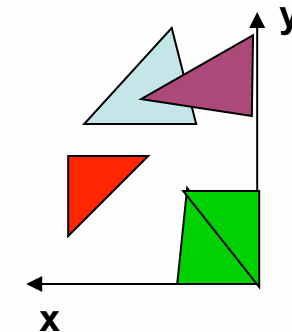

3D graphics rendering pipeline (3)

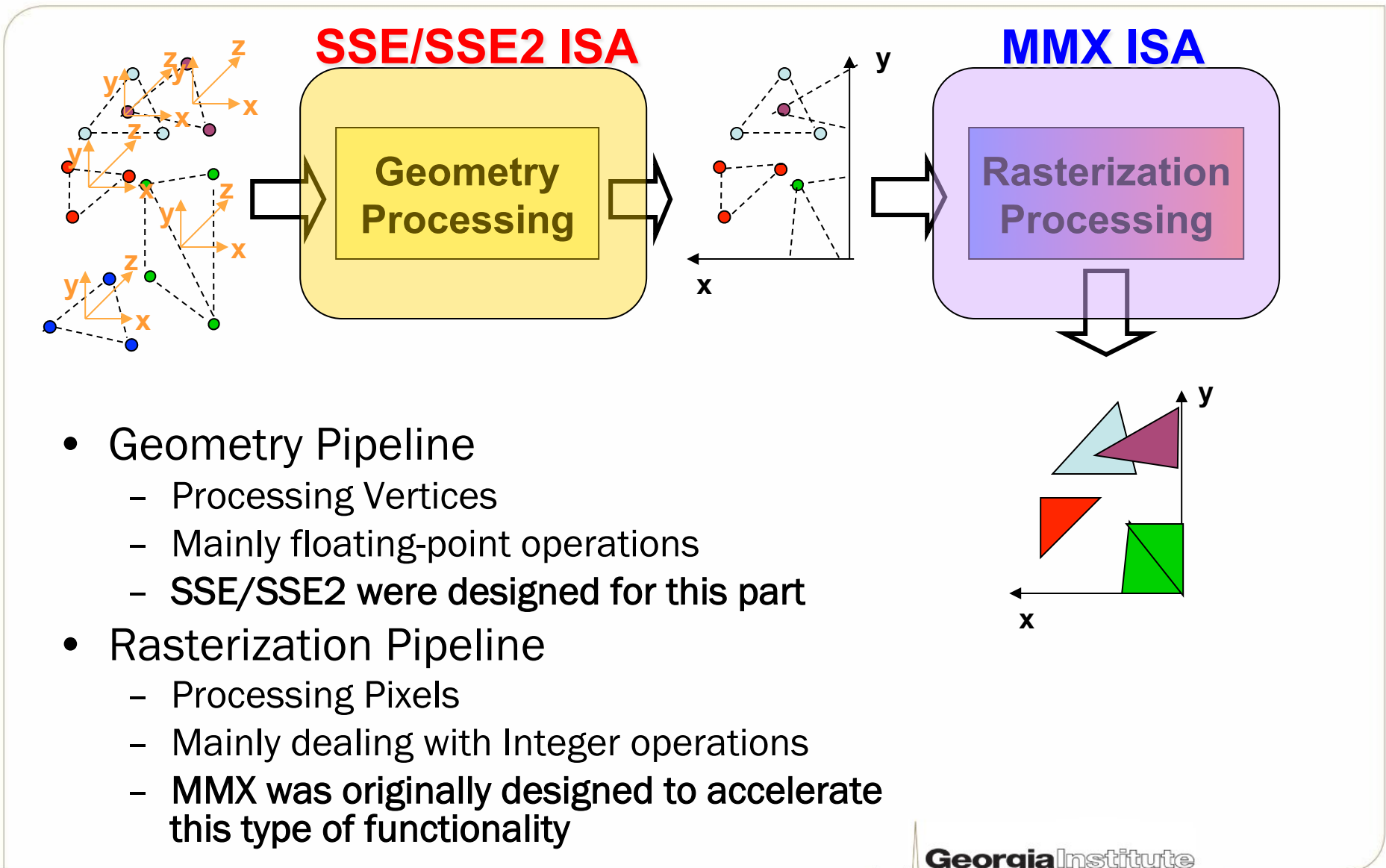

- Geometry Pipeline
 - Processing Vertices
 - Mainly floating-point operations
 - SSE/SSE2 were designed for this part
- Rasterization Pipeline
 - Processing Pixels
 - Mainly dealing with Integer operations
 - MMX was originally designed to accelerate this type of functionality

Fixed-function 3D graphics pipeline

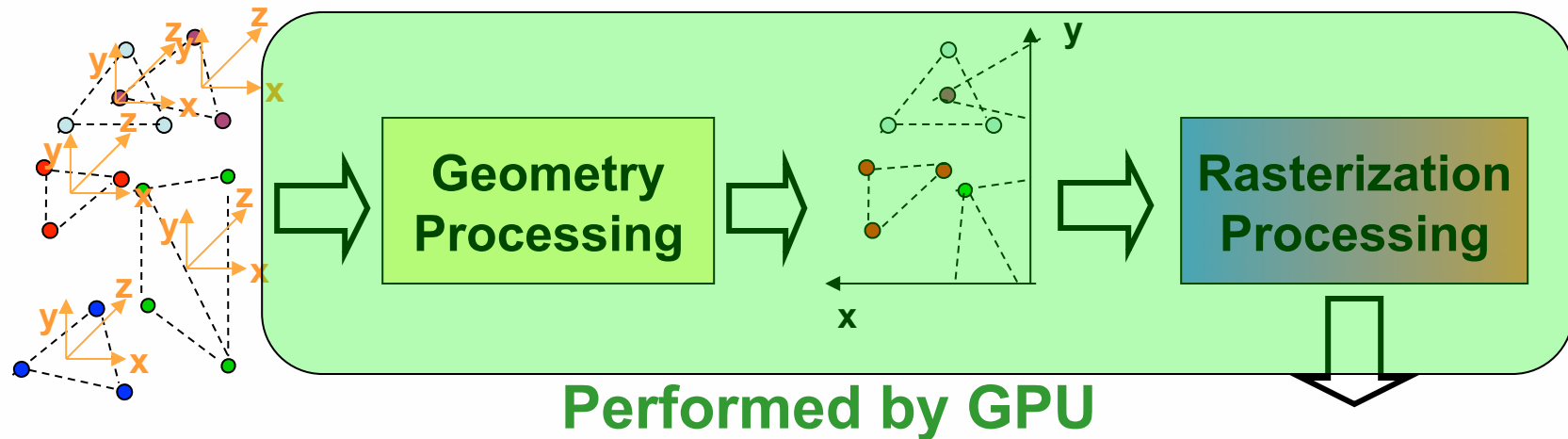

- Geometry Pipeline
 - Processing Vertices
 - Mainly floating-point operations
 - ~~SSE/SSE2 were designed for this part~~
- Rasterization Pipeline
 - Processing Pixels
 - Mainly dealing with Integer operations
 - ~~MMX was originally designed to accelerate this type of functionality~~

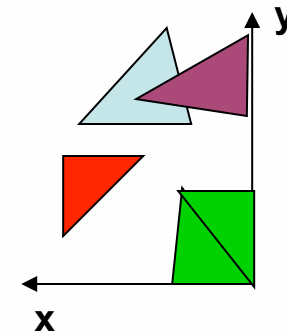

3D Coord: Math textbooks use z-up

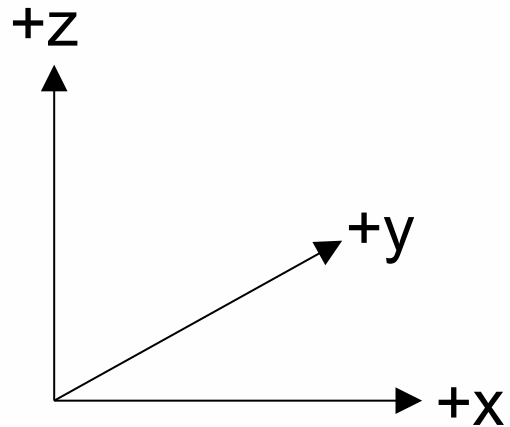

Z-up, Right-Handed System

3D Coord: Real games tend to use y-up

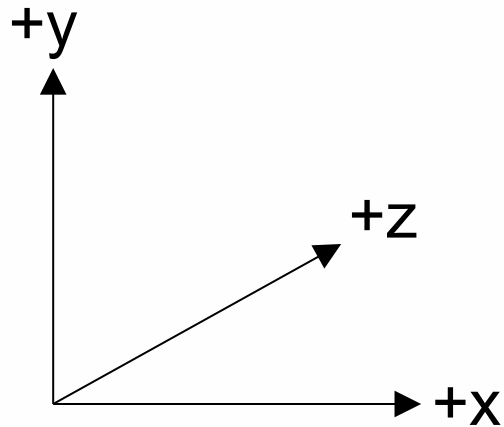

Left-Handed System

- Direct3D
- Unity3D

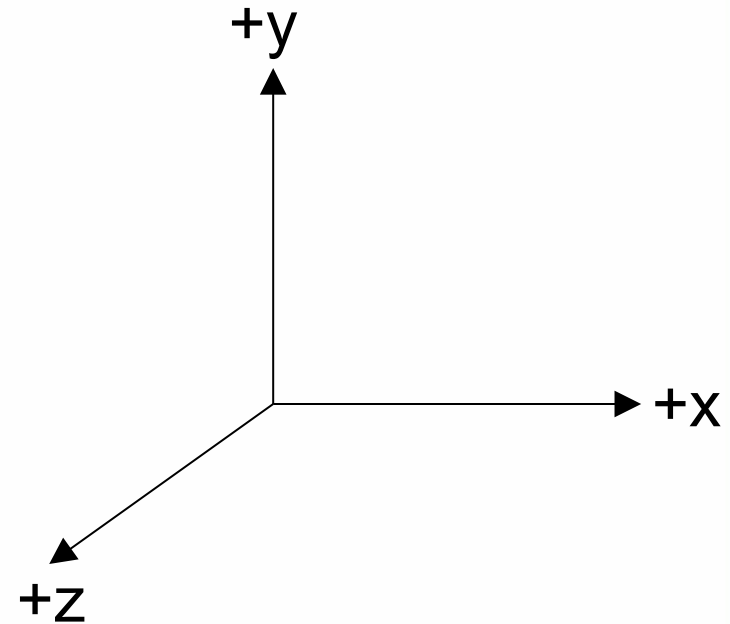

Right-Handed System

- OpenGL
- XNA

X-Y natural for screen coordinates

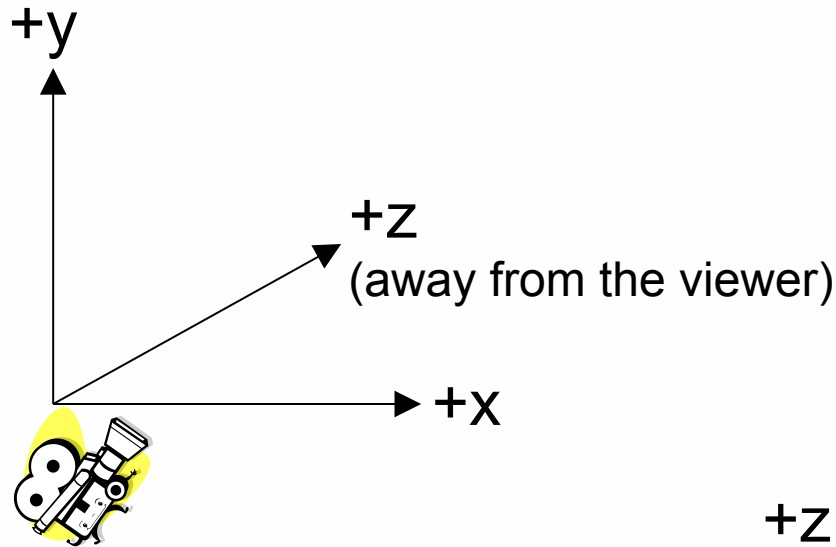

Left-Handed System

- Direct3D
- Unity3D

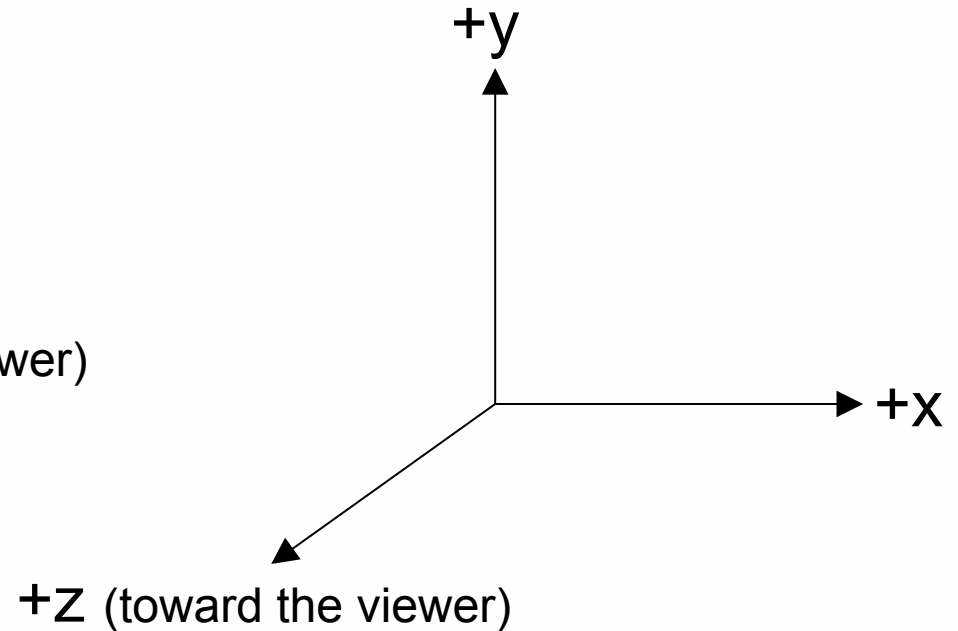

Right-Handed System

- OpenGL
- XNA

Some use Z-up for world coordinates

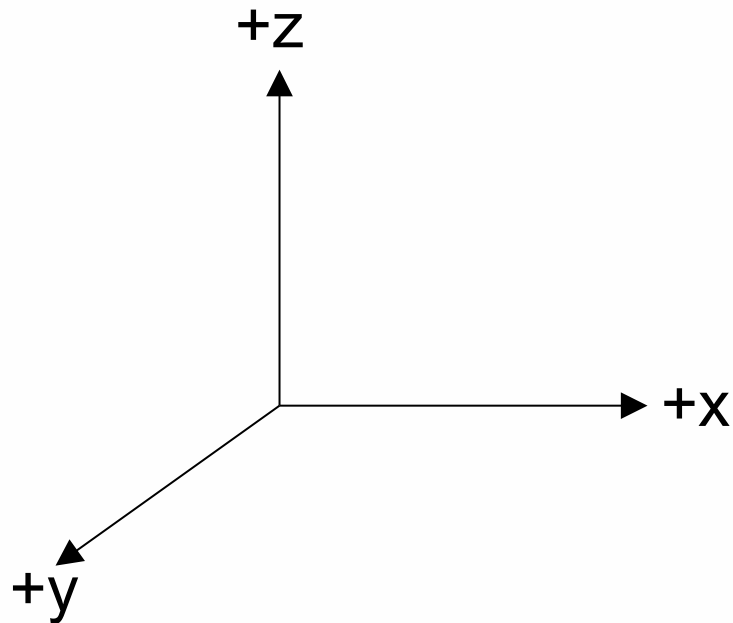

Left-Handed System

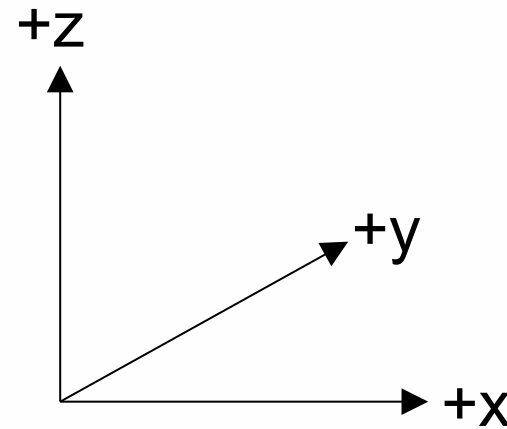

Right-Handed System

- Z-up, LHS: Unreal
- Z-up, RHS: Quake/Radiant, Source/Hammer, C4 Engine
- Nearly everything still uses Y-up for screen coordinates!

Another view

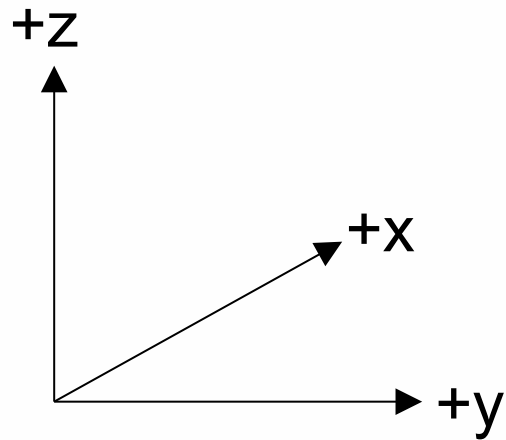

Left-Handed System

- Unreal

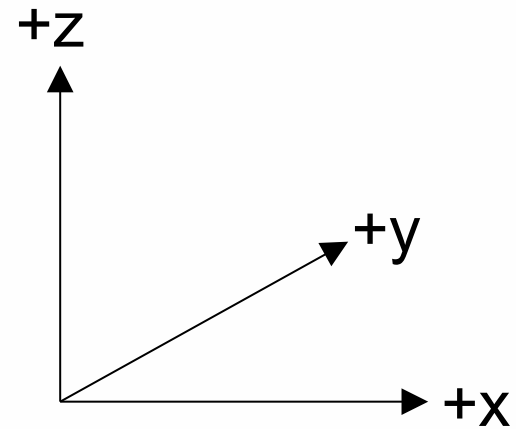

Right-Handed System

- Quake/Radiant
- Source/Hammer
- C4 Engine

3D “object” modeling software

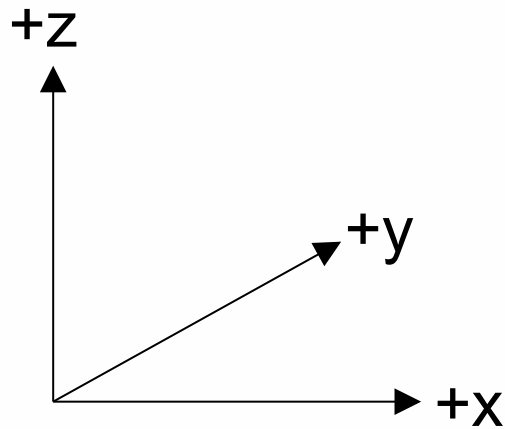

Right-Handed System

3D Studio Max, Blender

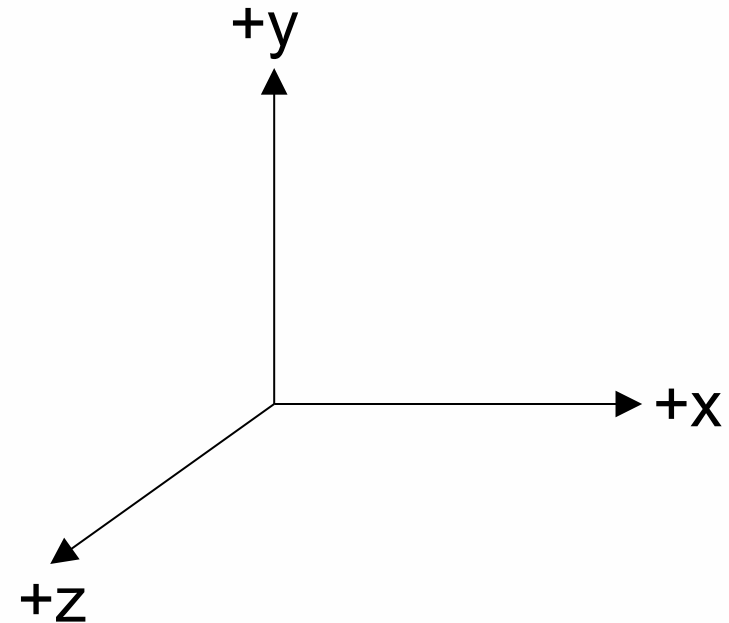

Right-Handed System

Maya, Milkshape

Geometry format – vertex coordinates

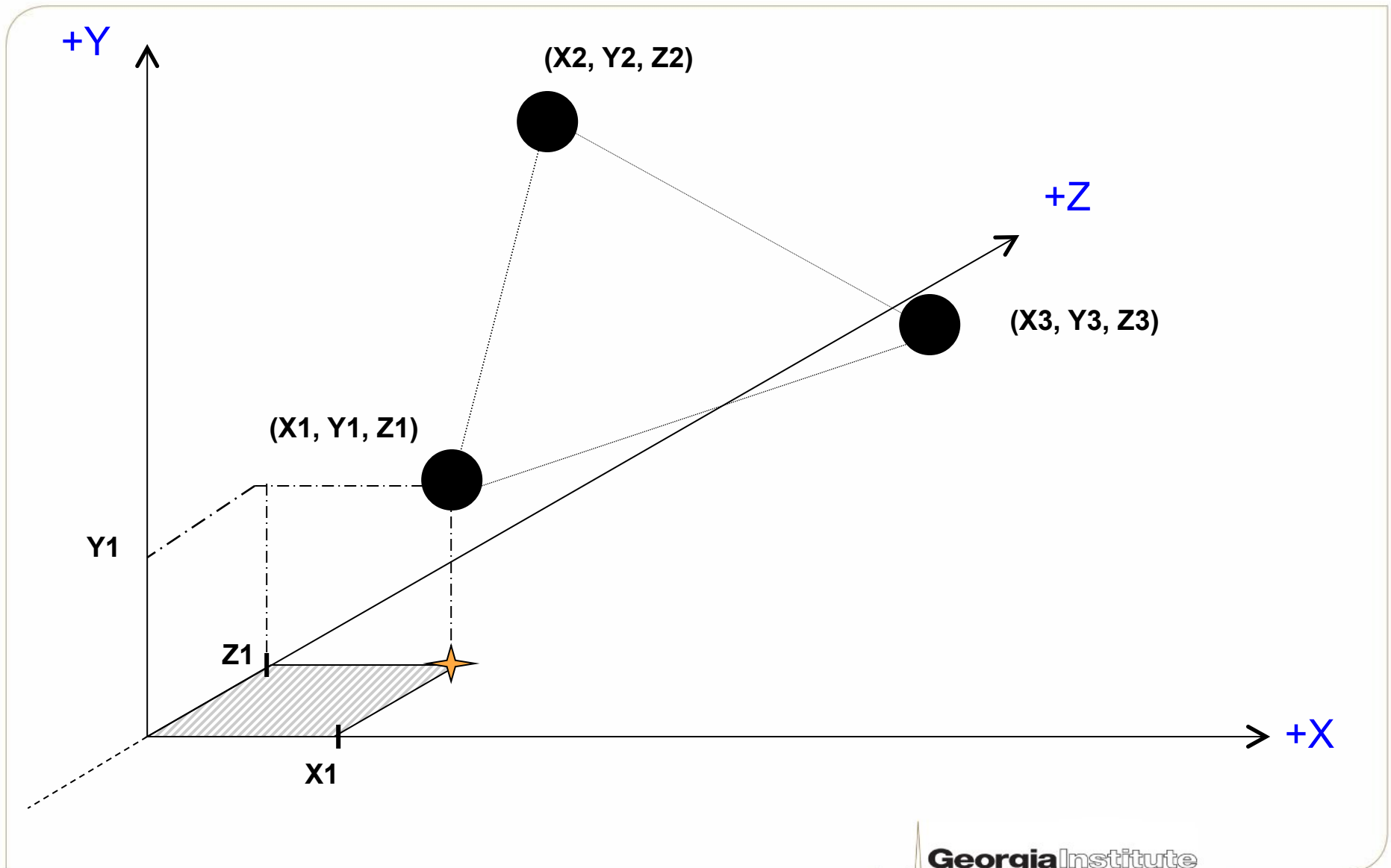

Geometry format – vertex normals

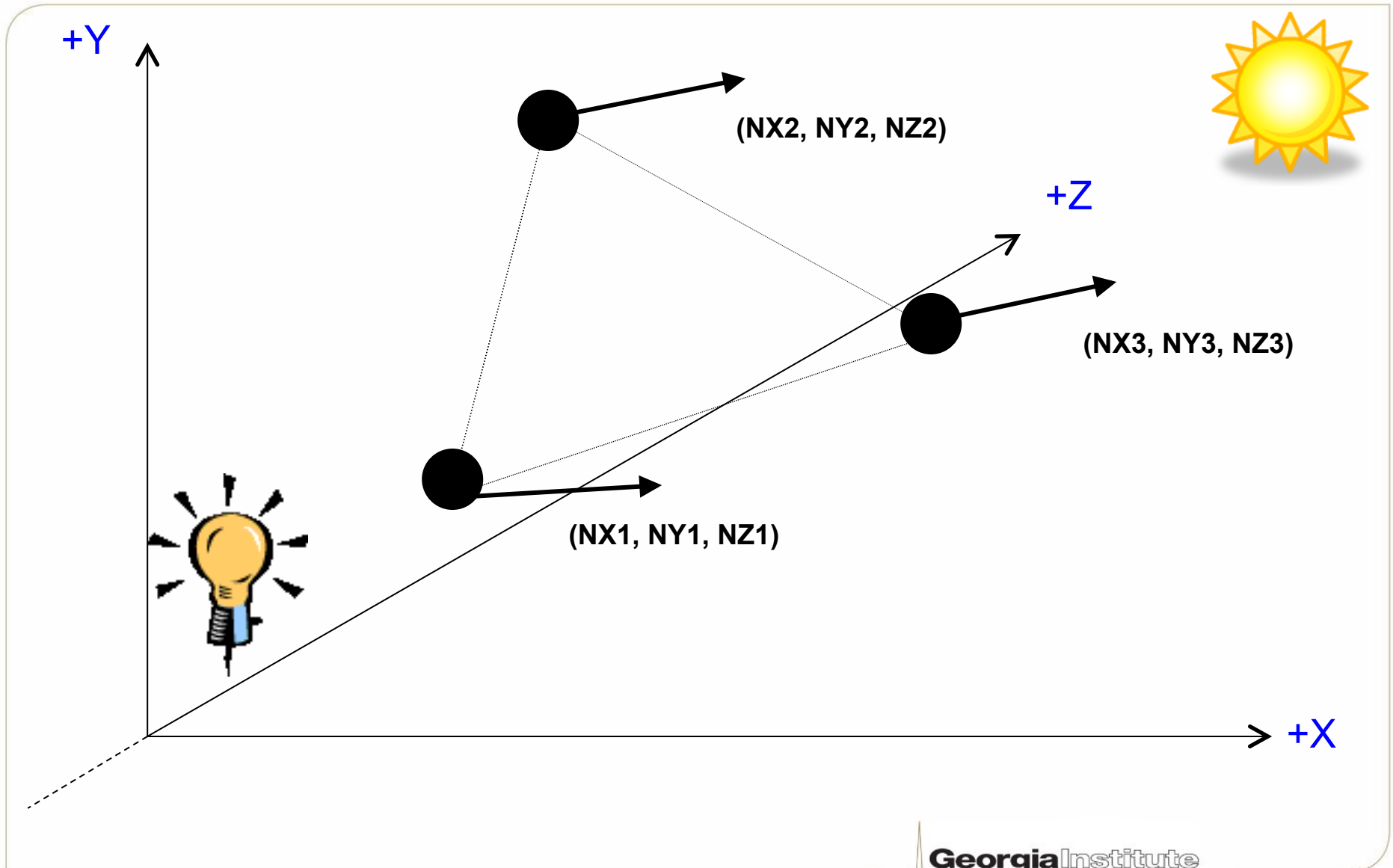

Geometry format – vertex colors

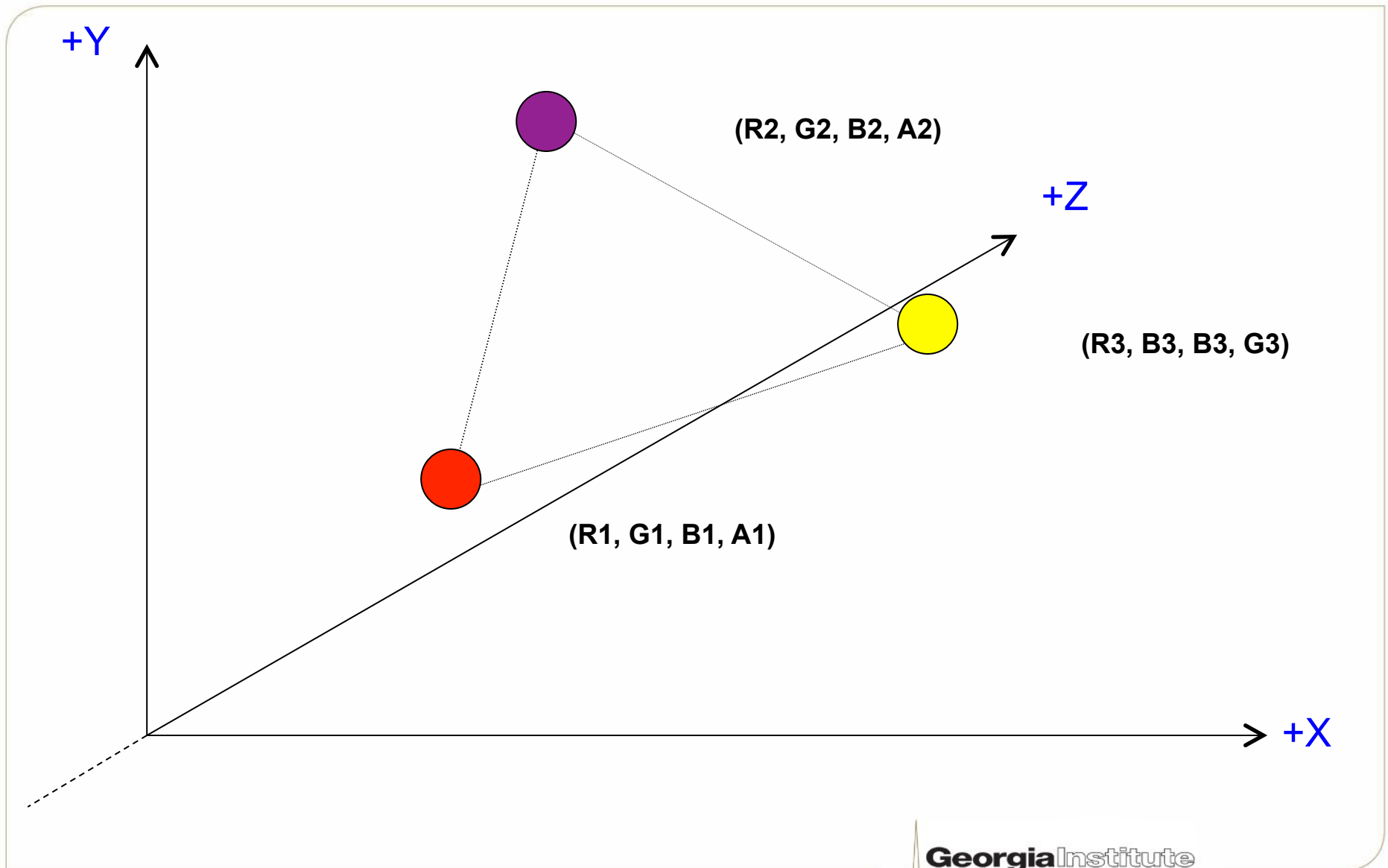

Triangle-based geometry representation

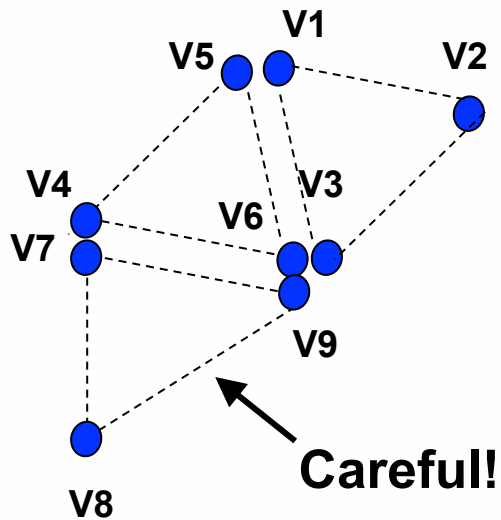

Triangle List
(note the vertex order)

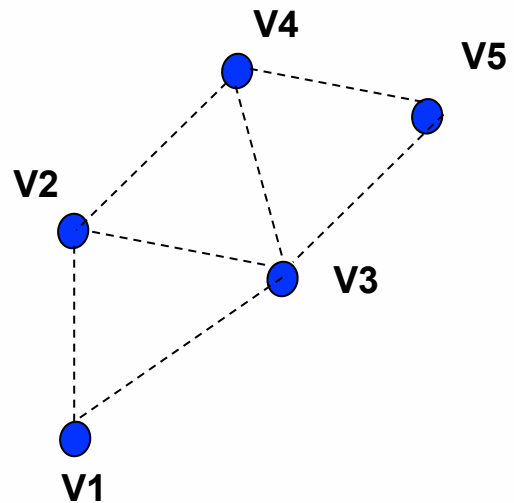

Triangle Strip

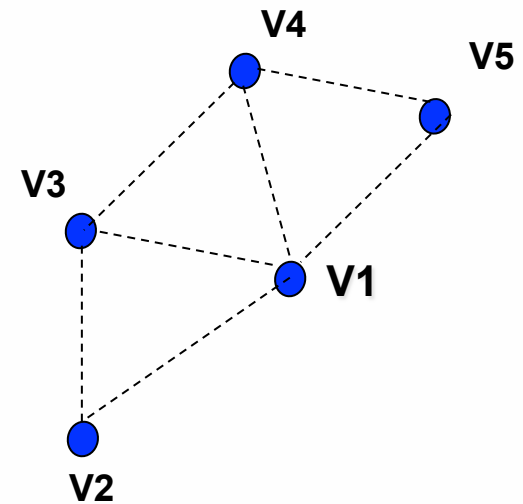

Triangle Fan

Specifying a 3D object (1)

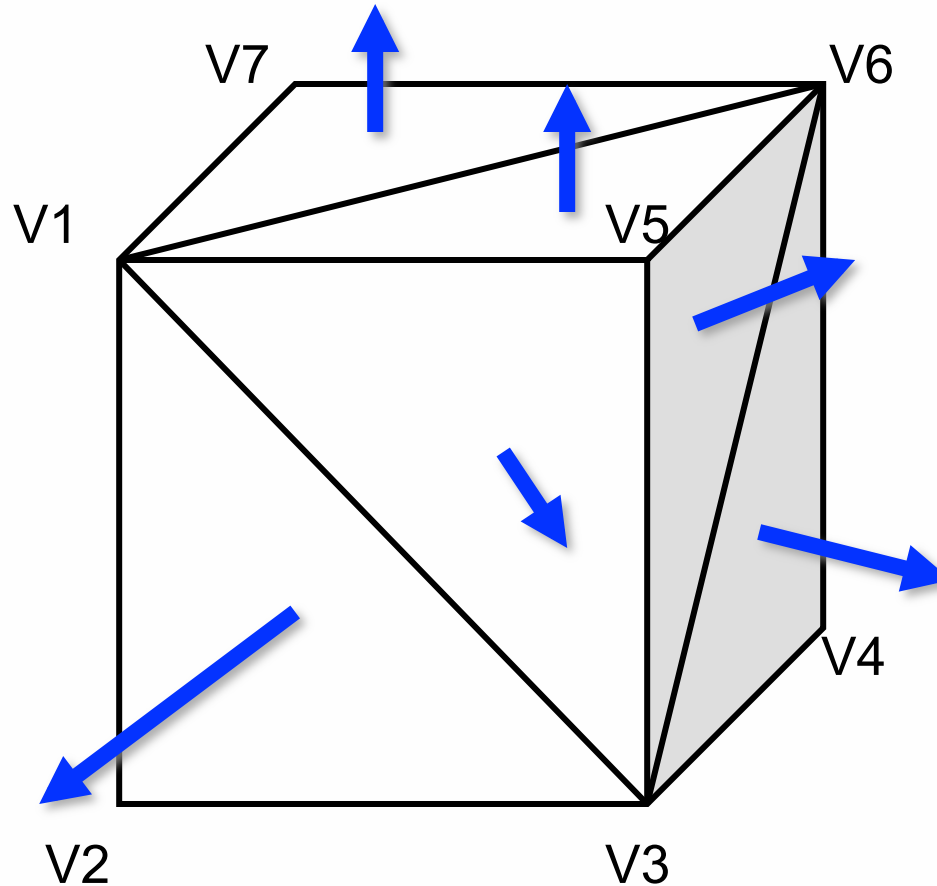

Triangle list
{v1, v3, v2},
{v1, v5, v3},
{v5, v6, v3},
{v4, v3, v6},
{v1, v7, v6},
{v1, v6, v5}

Triangle strip
{v5, v3, v1, v2},
{v5, v6, v3, v4},
{v7, v6, v1, v5}

- Vertex ordering is critical when culling mode enabled
- We will discuss normal computation later

Specifying a 3D object (2)

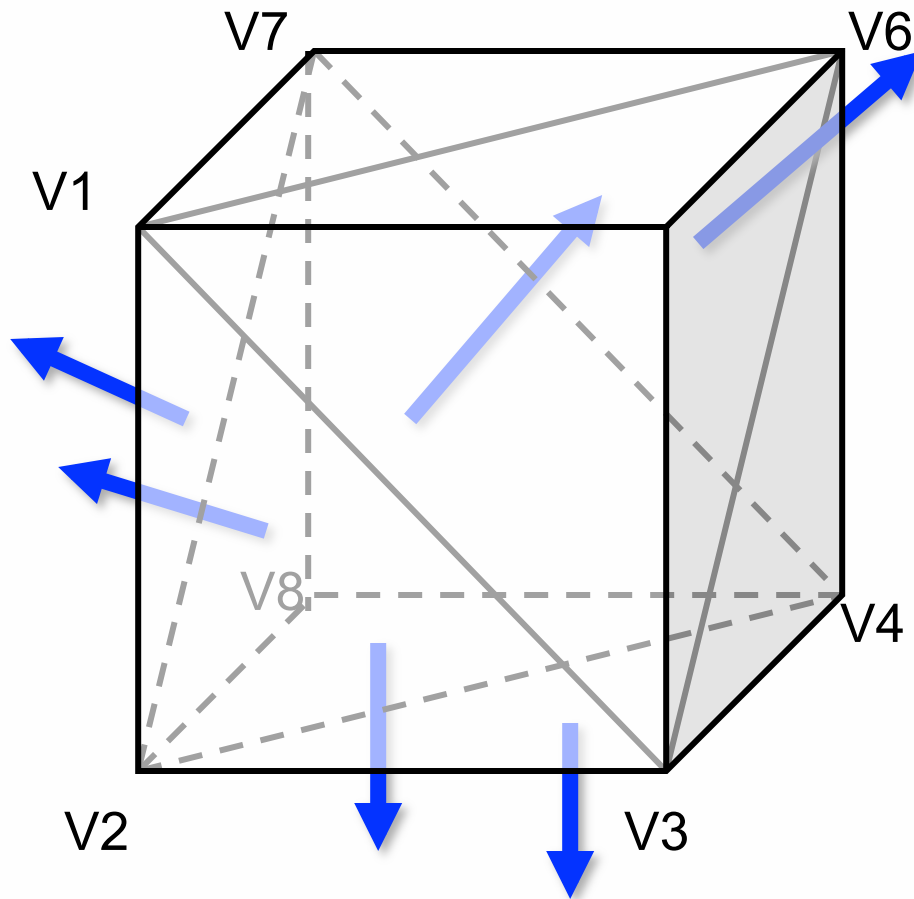

Triangle list
{v1, v2, v7},
{v2, v8, v7},
{v2, v3, v4},
{v2, v4, v8},
{v4, v7, v8},
{v4, v6, v7}

Triangle strip
{v1, v2, v7, v8},
{v3, v4, v2, v8},
{v6, v7, v4, v8}

- Vertex ordering is critical when culling mode enabled
- We will discuss normal computation later

3D rendering pipeline

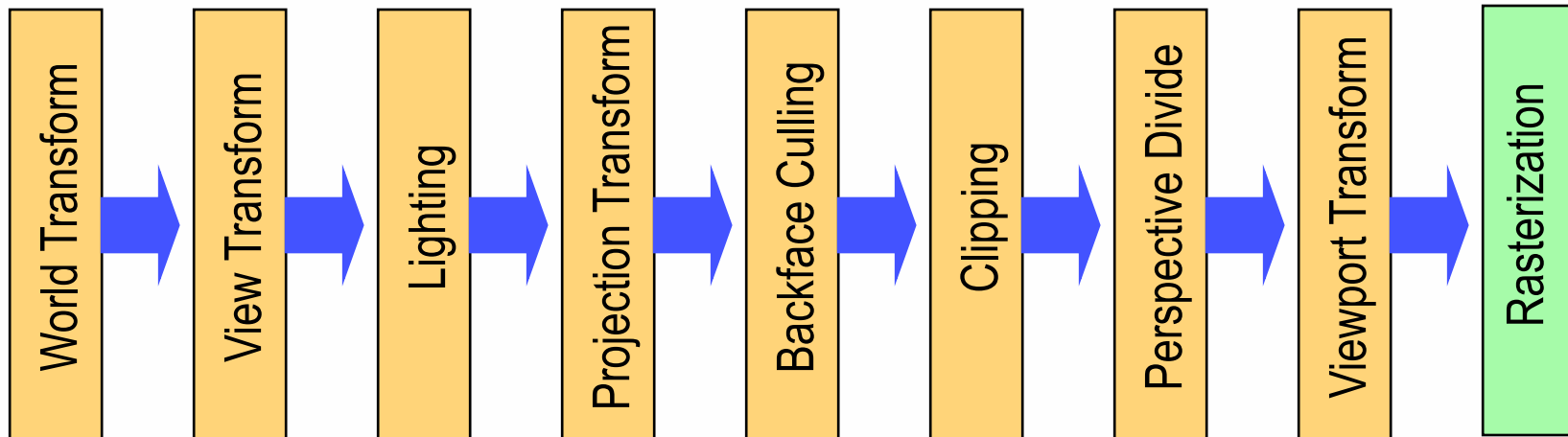

Transformation pipeline

- World Transformation
 - Model coordinates \rightarrow World coordinates
- View Transformation
 - World coordinates \rightarrow Camera space
- Projection Transformation
 - Camera space \rightarrow View plane
- These are a series of matrix multiplications

World transformation

World Coordinates

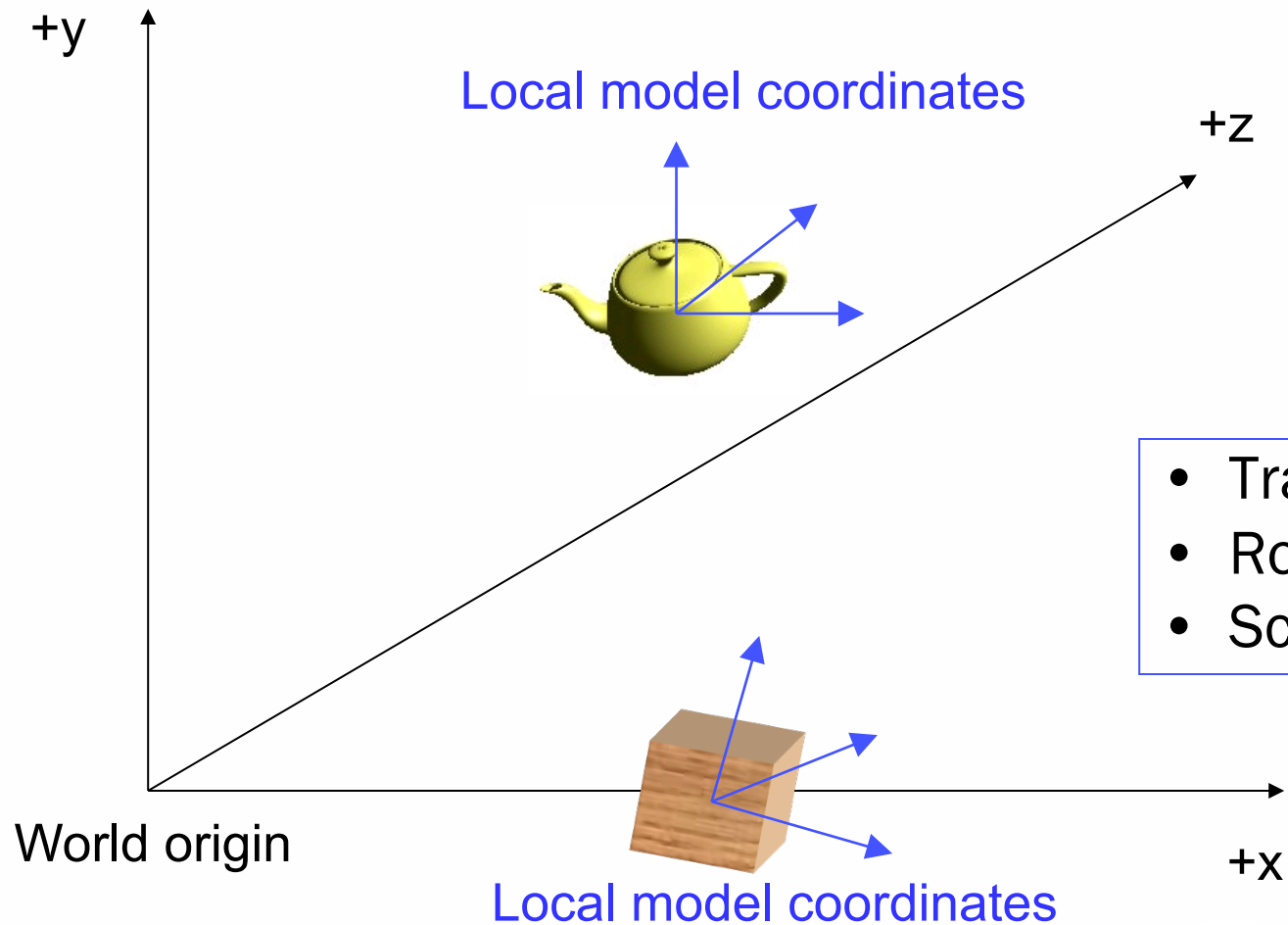

- Translation
- Rotation
- Scaling

View transformation

World Coordinates

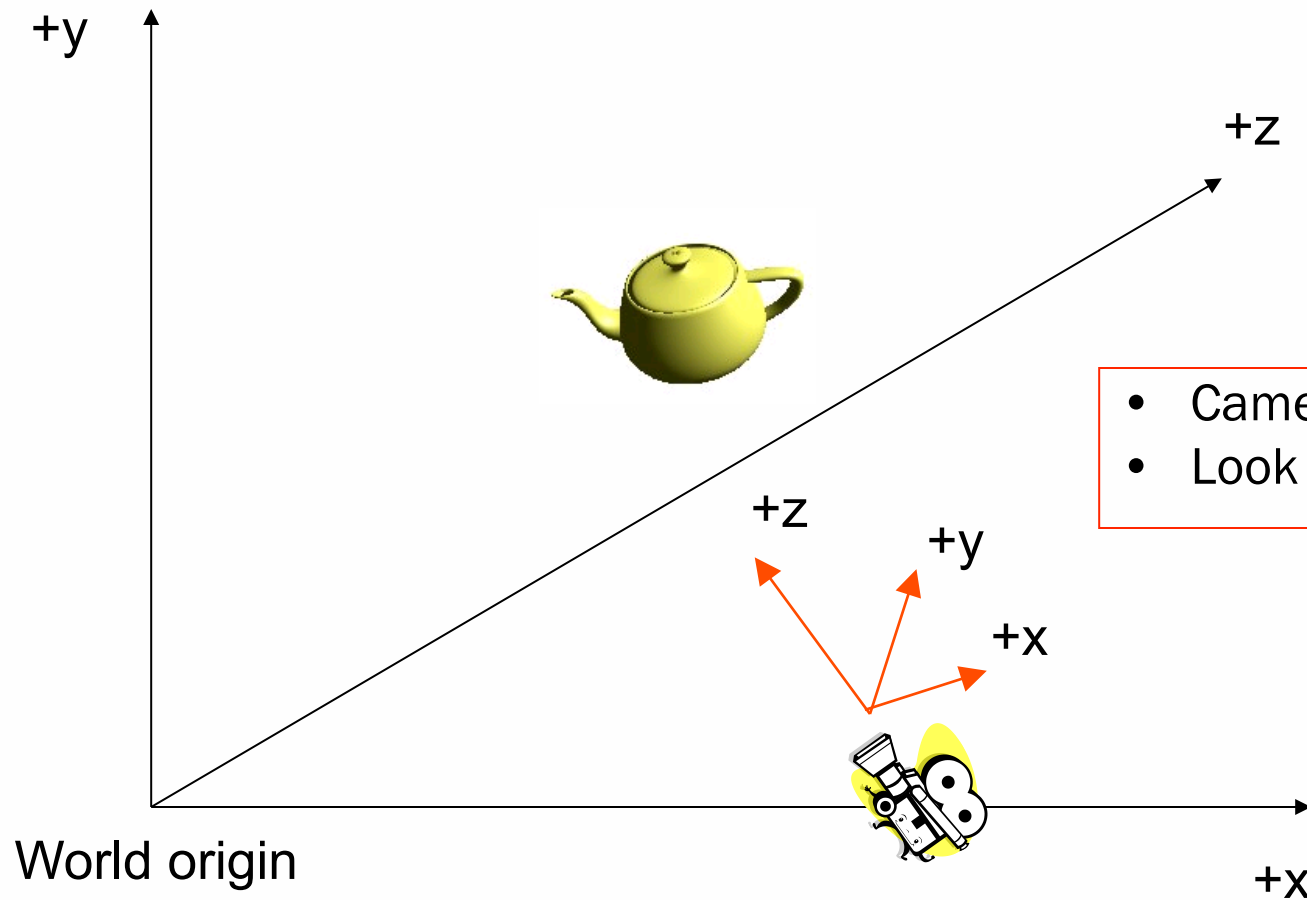

- Camera position
- Look vector

Projection transformation

- Set up camera internals
- Set up
 - Field of View (FOV)
 - View frustum
 - View planes
- Will discuss in the next lecture

Homogeneous coordinates

- Enable all transformations to be done by “*multiplication*”
 - Primarily for translation (see next few slides)
- Add one coordinate (w) to a 3D vector
- Each vertex has $[x, y, z, w]$
 - w will be useful for perspective projection
 - w should be 1 in a Cartesian coordinate system

Transformation 1: translation (Offset)

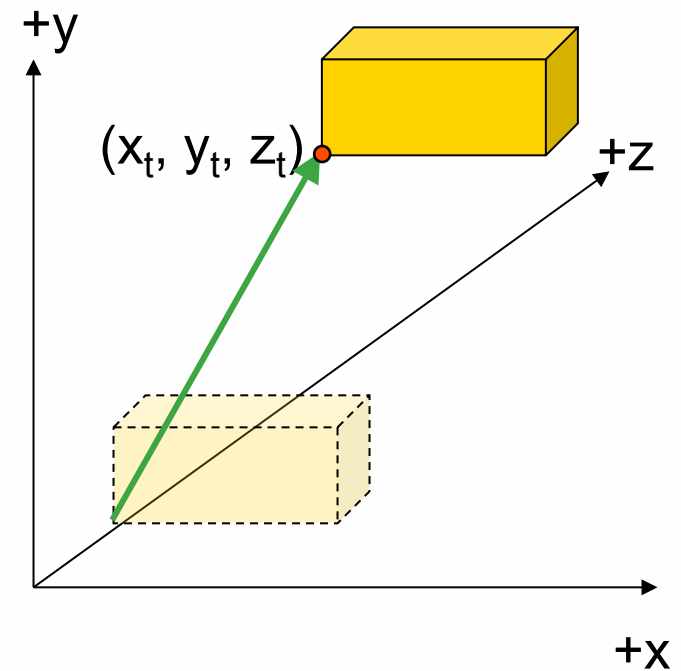
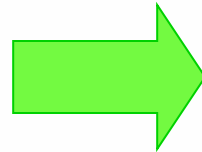
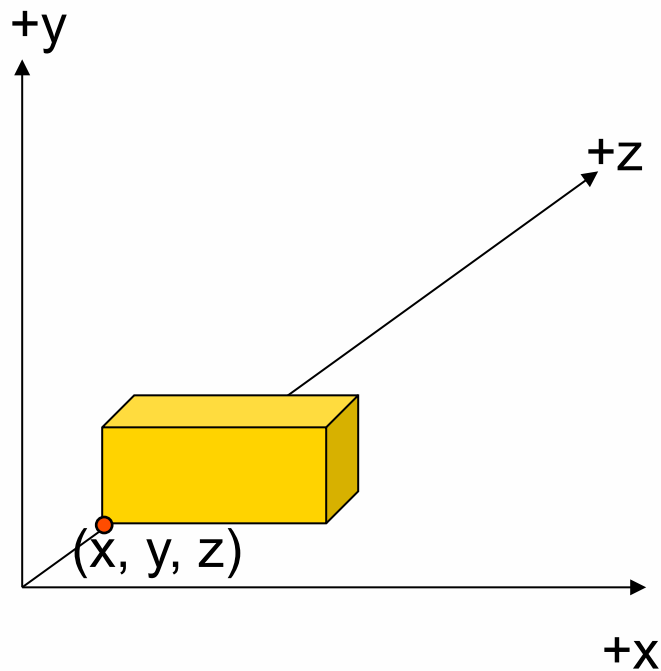

Translation matrix

$$[x_t, y_t, z_t, 1] = [x, y, z, 1] \cdot \begin{bmatrix} 1 & 0 & 0 & 0 \\ 0 & 1 & 0 & 0 \\ 0 & 0 & 1 & 0 \\ T_x & T_y & T_z & 1 \end{bmatrix}$$

- Example of a row-coordinate convention
- Direct3D, XNA, HLSL/Cg use row coordinates
- OpenGL, Unity & non-graphics world uses column coordinates (transpose matrices you see in remaining slides)

Transformation 2: scaling

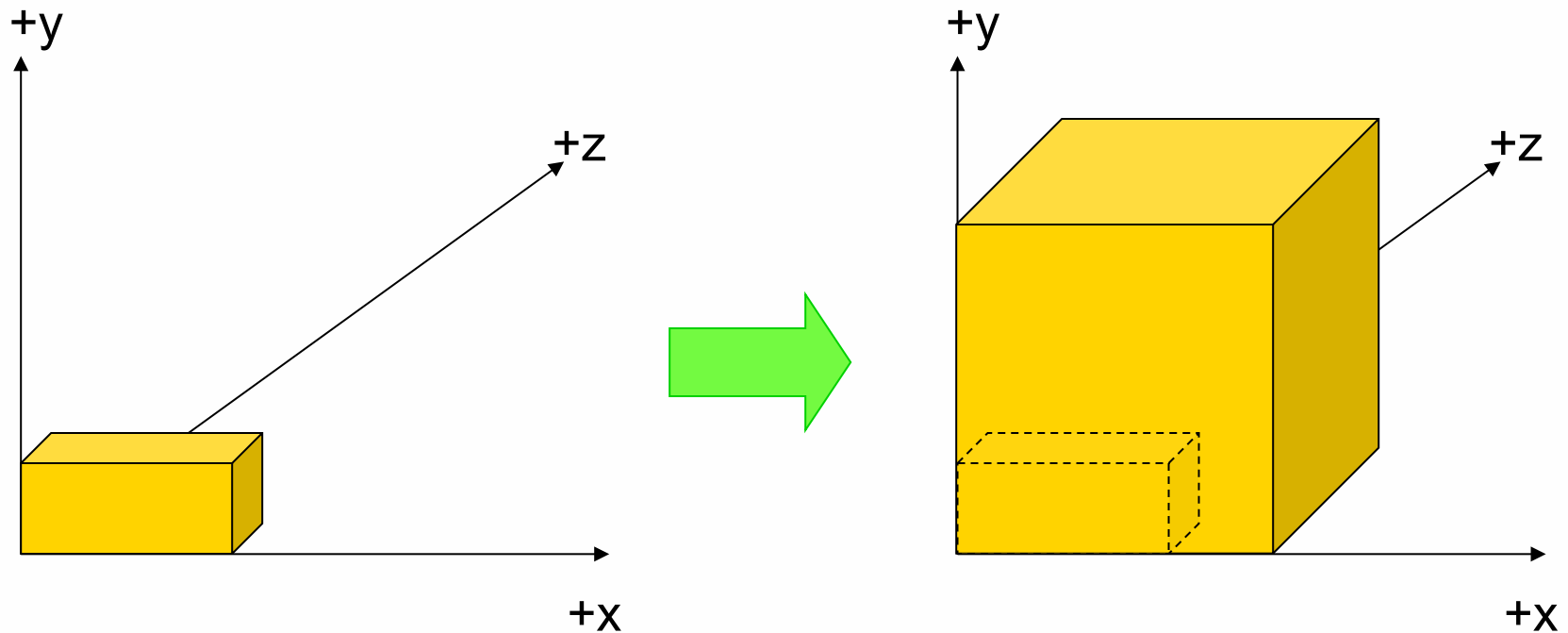

Scaling matrix

$$[X_s, y_s, Z_s, 1] = [X, y, z, 1] \cdot \begin{bmatrix} S_x & 0 & 0 & 0 \\ 0 & S_y & 0 & 0 \\ 0 & 0 & S_z & 0 \\ 0 & 0 & 0 & 1 \end{bmatrix}$$

Transformation 3: rotation

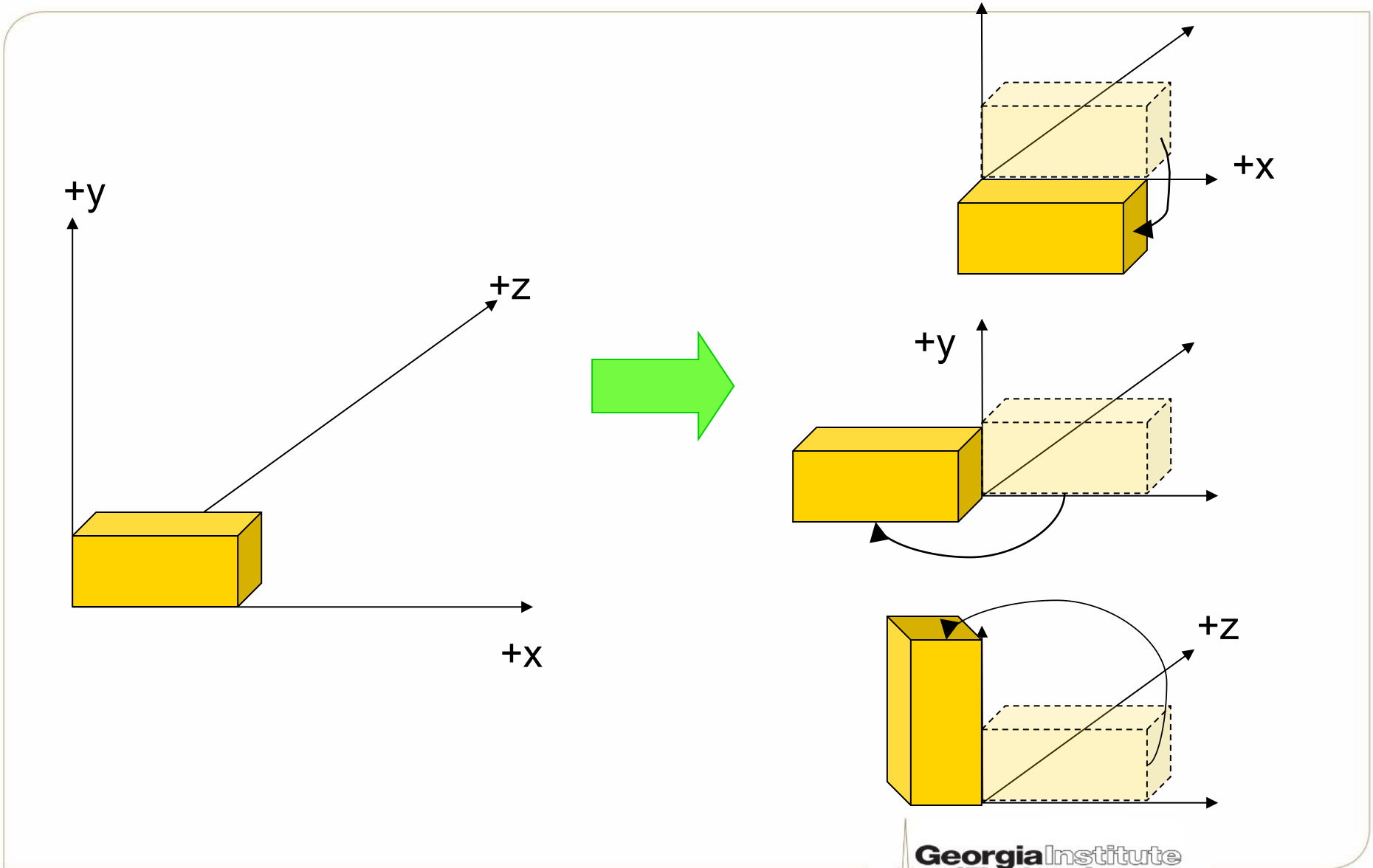

2D rotation

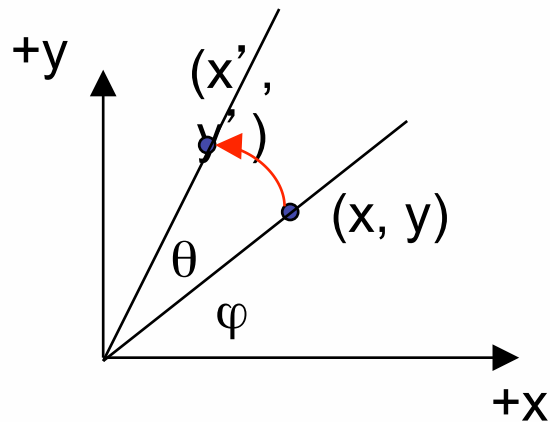
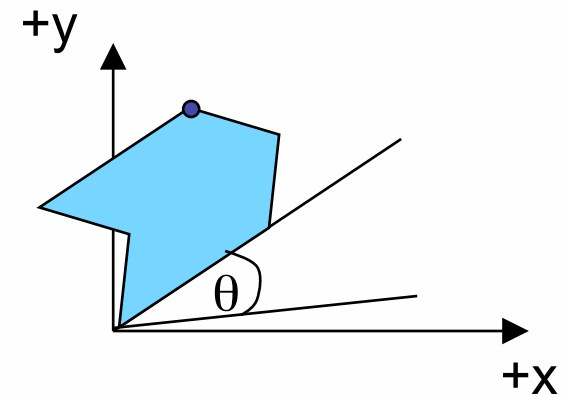
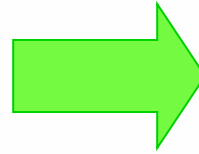
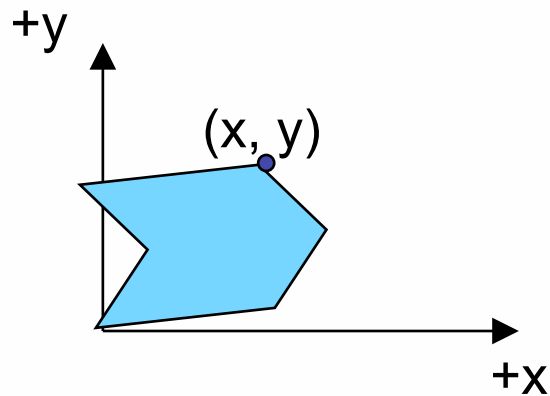

$$[x', y', 1] = [x, y, 1] \cdot \begin{bmatrix} \cos \theta & \sin \theta & 0 \\ -\sin \theta & \cos \theta & 0 \\ 0 & 0 & 1 \end{bmatrix}$$

Rotate along which axis?

3D rotation matrix (LHS)

Rotation along **Z** axis $[x', y', z', 1] = [x, y, z, 1] \cdot$

$$\begin{bmatrix} \cos \theta & \sin \theta & 0 & 0 \\ -\sin \theta & \cos \theta & 0 & 0 \\ 0 & 0 & 1 & 0 \\ 0 & 0 & 0 & 1 \end{bmatrix}$$

Rotation along **Y** axis $[x', y', z', 1] = [x, y, z, 1] \cdot$

$$\begin{bmatrix} \cos \theta & 0 & -\sin \theta & 0 \\ 0 & 1 & 0 & 0 \\ \sin \theta & 0 & \cos \theta & 0 \\ 0 & 0 & 0 & 1 \end{bmatrix}$$

Rotation along **X** axis $[x', y', z', 1] = [x, y, z, 1] \cdot$

$$\begin{bmatrix} 1 & 0 & 0 & 0 \\ 0 & \cos \theta & \sin \theta & 0 \\ 0 & -\sin \theta & \cos \theta & 0 \\ 0 & 0 & 0 & 1 \end{bmatrix}$$

Non-commutative property (1)

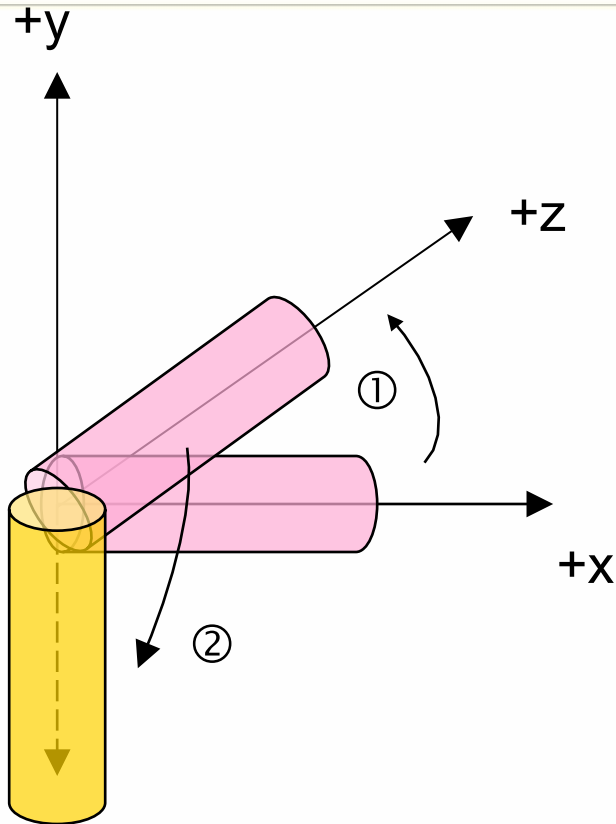

1. Counter-clockwise 90° along y
2. Clockwise 90° along x

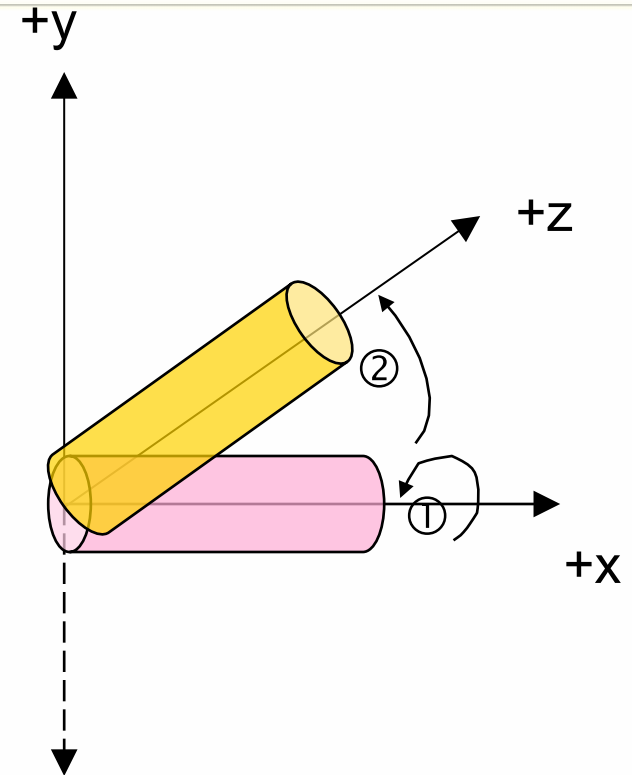

1. Clockwise 90° along x
2. Counter-clockwise 90° along y

Non-commutative property (2)

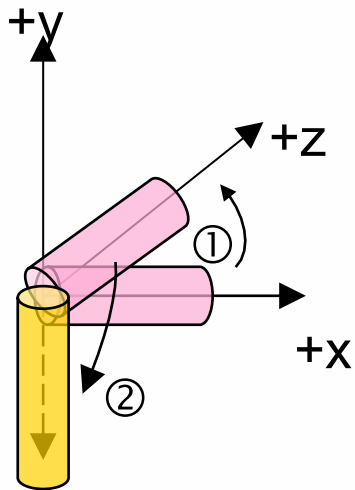

①

②

$$\begin{bmatrix} \cos(-\frac{\pi}{2}) & 0 & -\sin(-\frac{\pi}{2}) & 0 \\ 0 & 1 & 0 & 0 \\ \sin(-\frac{\pi}{2}) & 0 & \cos(-\frac{\pi}{2}) & 0 \\ 0 & 0 & 0 & 1 \end{bmatrix} \cdot \begin{bmatrix} 1 & 0 & 0 & 0 \\ 0 & \cos(\frac{\pi}{2}) & \sin(\frac{\pi}{2}) & 0 \\ 0 & -\sin(\frac{\pi}{2}) & \cos(\frac{\pi}{2}) & 0 \\ 0 & 0 & 0 & 1 \end{bmatrix} = \begin{bmatrix} 0 & -1 & 0 & 0 \\ 0 & 0 & 1 & 0 \\ -1 & 0 & 0 & 0 \\ 0 & 0 & 0 & 1 \end{bmatrix}$$

$$(x'', y'', z'') = (-z, -x, y)$$

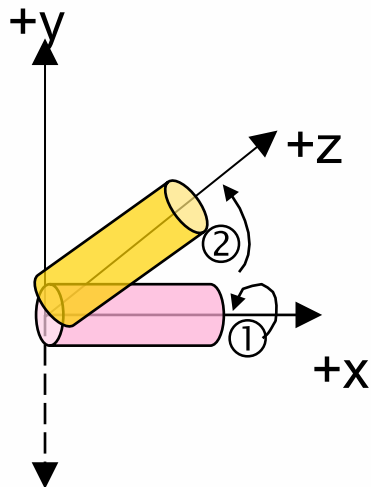

①

②

$$\begin{bmatrix} 1 & 0 & 0 & 0 \\ 0 & \cos(\frac{\pi}{2}) & \sin(\frac{\pi}{2}) & 0 \\ 0 & -\sin(\frac{\pi}{2}) & \cos(\frac{\pi}{2}) & 0 \\ 0 & 0 & 0 & 1 \end{bmatrix} \cdot \begin{bmatrix} \cos(-\frac{\pi}{2}) & 0 & -\sin(-\frac{\pi}{2}) & 0 \\ 0 & 1 & 0 & 0 \\ \sin(-\frac{\pi}{2}) & 0 & \cos(-\frac{\pi}{2}) & 0 \\ 0 & 0 & 0 & 1 \end{bmatrix} = \begin{bmatrix} 0 & 0 & 1 & 0 \\ -1 & 0 & 0 & 0 \\ 0 & -1 & 0 & 0 \\ 0 & 0 & 0 & 1 \end{bmatrix}$$

$$(x'', y'', z'') = (-y, -z, x)$$

Non-commutative property (3)

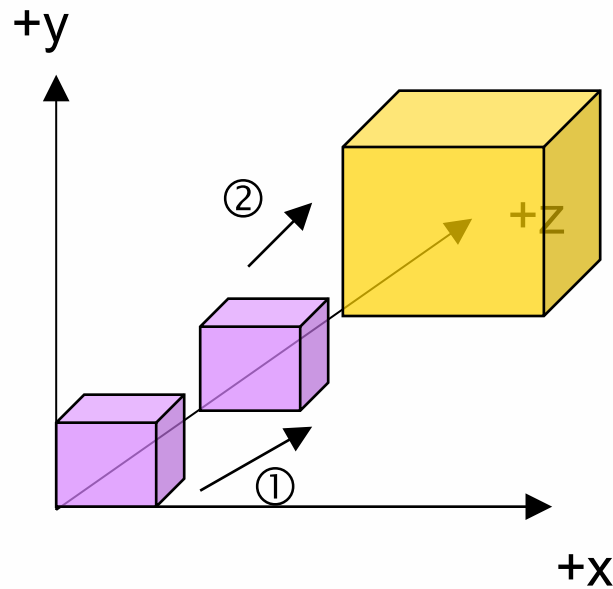

1. Translation by (x, y, z)
2. Scale by 2 times

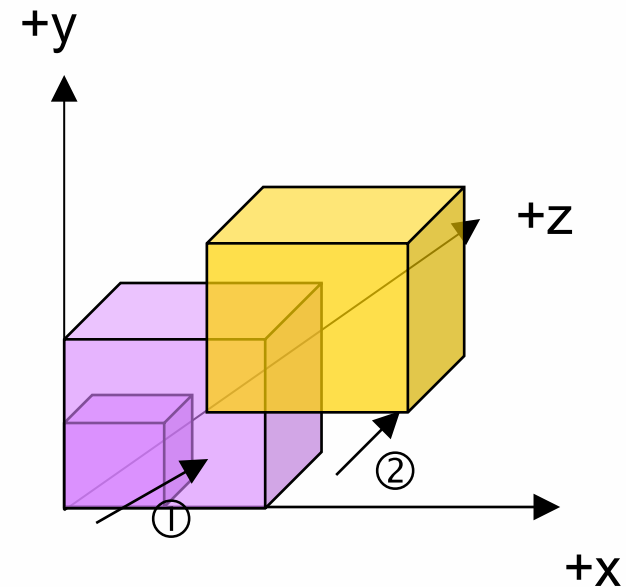

1. Scale by 2 times
2. Translation by (x, y, z)

Non-commutative property (4)

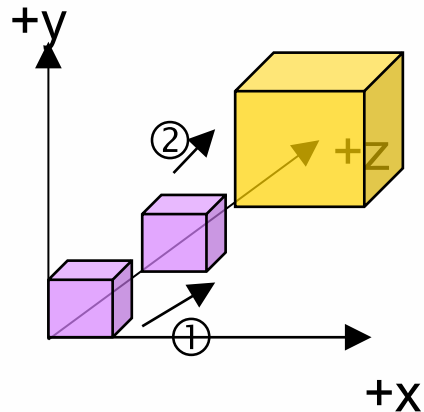

$$\begin{matrix} \textcircled{1} & \textcircled{2} \\ \begin{bmatrix} 1 & 0 & 0 & 0 \\ 0 & 1 & 0 & 0 \\ 0 & 0 & 1 & 0 \\ T_x & T_y & T_z & 1 \end{bmatrix} & \begin{bmatrix} S_x & 0 & 0 & 0 \\ 0 & S_y & 0 & 0 \\ 0 & 0 & S_z & 0 \\ 0 & 0 & 0 & 1 \end{bmatrix} & = & \begin{bmatrix} S_x & 0 & 0 & 0 \\ 0 & S_y & 0 & 0 \\ 0 & 0 & S_z & 0 \\ S_x T_x & S_y T_y & S_z T_z & 1 \end{bmatrix} \end{matrix}$$

$$(x'', y'', z'') = (x * S_x + S_x * T_x, y * S_y + S_y * T_y, z * S_z + S_z * T_z)$$

↑ Offsets were scaled as well

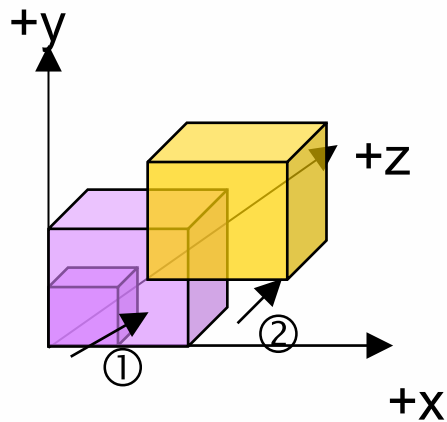

$$\begin{matrix} \textcircled{1} & \textcircled{2} \\ \begin{bmatrix} S_x & 0 & 0 & 0 \\ 0 & S_y & 0 & 0 \\ 0 & 0 & S_z & 0 \\ 0 & 0 & 0 & 1 \end{bmatrix} & \begin{bmatrix} 1 & 0 & 0 & 0 \\ 0 & 1 & 0 & 0 \\ 0 & 0 & 1 & 0 \\ T_x & T_y & T_z & 1 \end{bmatrix} & = & \begin{bmatrix} S_x & 0 & 0 & 0 \\ 0 & S_y & 0 & 0 \\ 0 & 0 & S_z & 0 \\ T_x & T_y & T_z & 1 \end{bmatrix} \end{matrix}$$

$$(x'', y'', z'') = (x * S_x + T_x, y * S_y + T_y, z * S_z + T_z)$$

Non-commutative property (5)

- Ordering matters !
- Be careful when performing matrix multiplication

View transformation revisited

World Coordinates

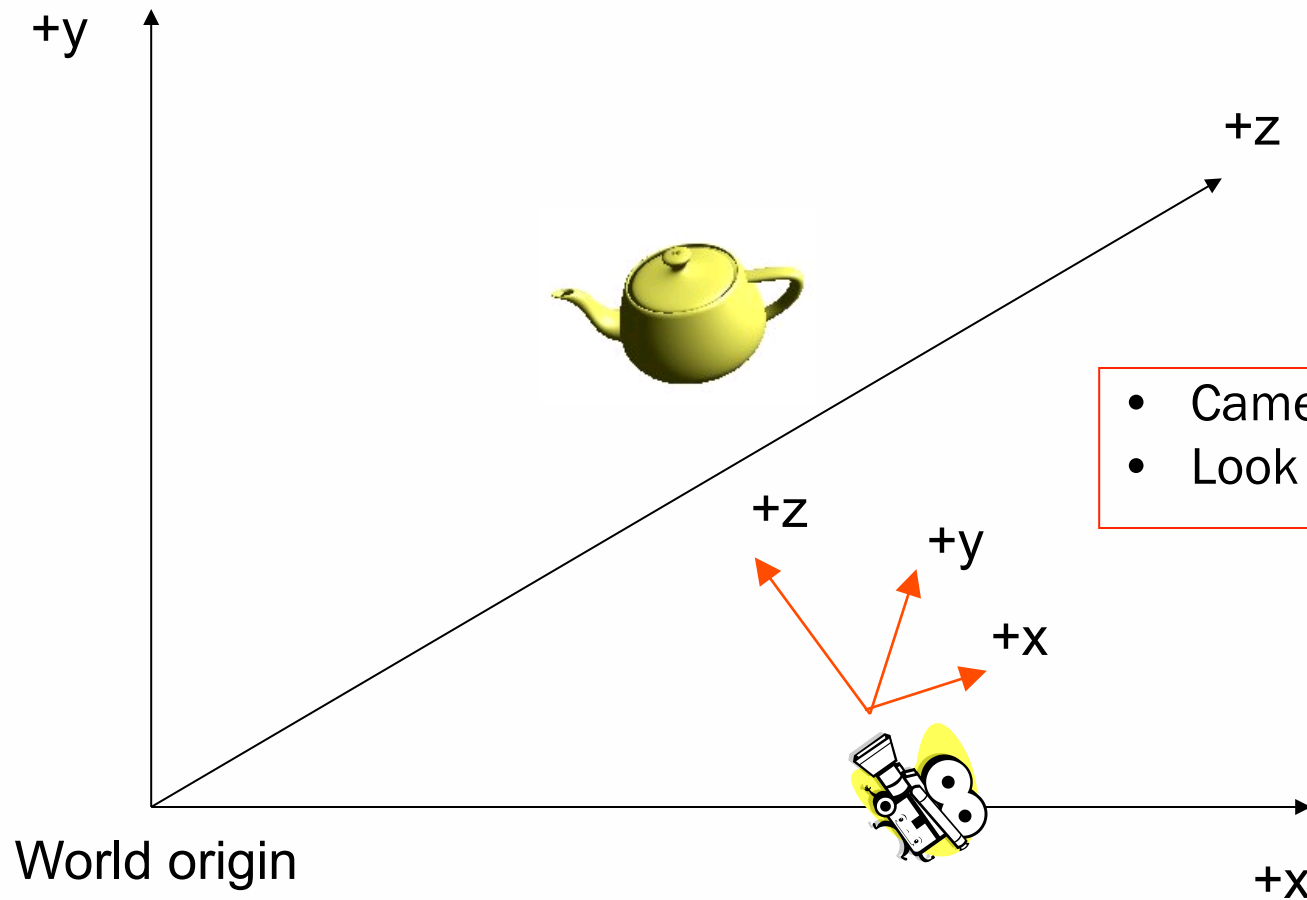

Specifying the view transformation

- Most commonly parameterized by:
 - Position of camera
 - Position of point to look at
 - Vector indicating “up” direction of camera
- In Direct3D: `D3DXMatrixLookAtLH`
 - D3D uses a LHS, but also have `D3DXMatrixLookAtRH`
- In XNA: `Matrix.CreateLookAt` (RHS)
- In OpenGL: `gluLookAt` (RHS)
- Can also build a rotation+translation matrix as if the camera was an object in scene, then take the inverse of that matrix